



**JSW THE JAPAN STEEL WORKS, LTD.**

URL <http://www.jsw.co.jp/>

Division Gate City Ohsaki-West Tower, 11-1, Osaki 1-chome, Shinagawa-ku,  
 Head Quarter: Tokyo 141-0032, Japan  
 Phone: +81-3-5745-2081 Fax: +81-3-5745-2083~84  
 URL [http://www.jsw.co.jp/inj\\_f/inj\\_index.htm](http://www.jsw.co.jp/inj_f/inj_index.htm)

**JSW Plastics Machinery Inc.**

Head Office: 555 South Promenade Ave., Unit 104, Corona, California 92879, U.S.A.  
 Phone: +1-951-898-0934 Fax: +1-951-898-0944  
 Chicago Office: 540 Capital Drive, Suite 130, Lake Zurich, Illinois 60047, U.S.A.  
 Phone: +1-847-550-0704 Fax: +1-847-550-0725  
 Detroit Office: 24300 Catherine Industrial Drive, Suite 403, Novi, Michigan 48375, U.S.A.  
 Phone: +1-248-308-2822

**The Japan Steel Works (Singapore) Pte. Ltd.**

17 Gul Lane 629413 Singapore  
 Phone: +65-68614511 Fax: +65-68623166

**PT. JSW Plastics Machinery Indonesia**

Gajah Building Unit K, Jl.Dr.Saharjo No.111 Tebet,Jakarta Selatan 12810, Indonesia  
 Phone: +62-21-8370-2536 Fax: +62-21-829-8264

**JSW Plastics Machinery (Philippines) Inc.**

Unit 802 Alabang Business Tower, 1216 Acacia Avenue, Madrigal Business Park Alabang Muntinlupa City Metro Manila 1771, Philippines  
 Phone: +63-2-478-2533 Fax: +63-2-809-6221

**JSW Plastics Machinery (M) SDN. BHD.**

D6-5-G,(Ground Floor), Block D6, Pusat Perdagangan Dana 1, Jalan Pju 1A/46, 47301, Petaling Jaya, Selangor Darul Ehsan, Malaysia  
 Phone: +60-3-78426076 Fax: +60-3-78426078

**The Japan Steel Works (Thailand) Co., Ltd.**

78/6 JST Building 4th Fl., Moo 7 King Kaew Road, Rachatewa, Bangplee, Samutprakarn 10540 Thailand  
 Phone: +66-2-738-5272 Fax: +66-2-738-5277

**JSW Plastics Machinery Vietnam Ltd.**

Room103, Techno-Center Thang Long Industrial Park Dong Anh District, Hanoi, Viet Nam  
 Phone: +84-4-3951-6383 Fax: +84-4-3951-6384

**JSW Plastics Machinery (H.K.) Co., Ltd.**

Room 907, Corporation Park, 11 On Lai Street, Shatin N.T., Hong Kong  
 Phone: +852-2648-0720 Fax: +852-2686-8204

**JSW Injection Machine Maintenance (Shenzhen) Co., Ltd.**

1F, YiBen Electronic & Business Industrial Park, No.1063 Chaguang Road, Xili Town, Nanshan District, Shenzhen City,Guangdong Province, 518055, People's Republic of China  
 Phone: +86-755-8602-0930 Fax: +86-755-8602-0934

**JSW Machinery Trading (Shanghai) Co., Ltd.**

28A, Strength Plaza, No.600-4, Tianshan Road, Shanghai, 200051, People's Republic of China  
 Phone: +86-21-5206-7031 Fax: +86-21-5206-7033

**JSW Plastics Machinery (TAIWAN) Corp.**

Head Office: 1F., No.21, Da Hu 1st Road, Guieshan Shiang Taoyuan Country 33373 Taiwan, R.O.C.  
 Phone: +886-3-396-2102 Fax: +886-3-396-2104  
 Tainan Office: 15F.,-7, No.689-78, Xiaodong Road, Yongkang City, Tainan Country 71052 Taiwan, R.O.C.  
 Phone: +886-6-311-4192 Fax: +886-6-311-4193

**Japan Steel Works India Private Limited**

611, Time Tower, MG Road, Sector 28, Gurgaon, haryana, 122001, India  
 Phone:+91-124-469-4444, Fax:+91-124-469-4433

**JADS SERIES**

All Electric Servo Drive Injection Molding Machine



Model  
**J220ADS | J280ADS | J350ADS | J450ADS**  
 - In U.S. Unit -

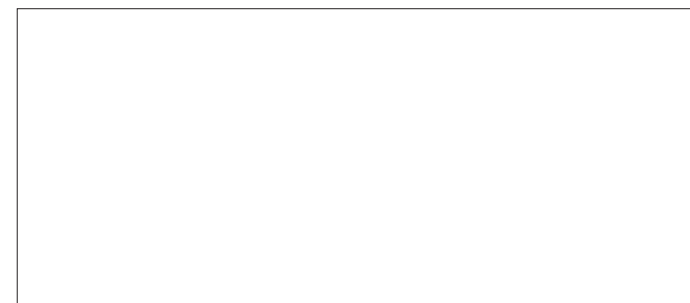

## Performance Table

## Equipment Dimensions and Mold Related Dimensions

Unit : inch (mm)

Unit	Item	Model	J220ADS									
			300H			460H				890H		
Standard Injection Unit	Screw Diameter	in (mm)	1.57 (40)	1.81 (46)	2.01 (51)	1.81 (46)	2.09 (53)	2.28 (58)	2.28 (58)	2.60 (66)	2.83 (72)	
	Screw Stroke	in (mm)	7.087 (180)			8.268 (210)				10.236 (260)		
	Theoretical Injection Capacity	in <sup>3</sup> (cm <sup>3</sup> )	13.79 (226)	18.25 (299)	22.46 (368)	21.30 (349)	28.26 (463)	33.87 (555)	41.93 (687)	54.31 (890)	64.63 (1059)	
	Injection Capacity (GP-PS)	oz (g)	7.3 (206)	9.6 (273)	11.8 (335)	11.2 (318)	14.9 (421)	17.8 (505)	22.0 (625)	28.6 (810)	34.0 (965)	
	Injection Pressure (Max.)	psi (Mpa)	36,260 (250)	27,410 (189)	22,340 (154)	33,940 (234)	25,670 (177)	21,320 (147)	33,210 (229)	25,670 (177)	21,610 (149)	
	Holding Pressure (Max.)	psi (Mpa)	32,920 (227)	24,950 (172)	20,310 (140)	30,890 (213)	23,350 (161)	19,430 (134)	30,170 (208)	23,350 (161)	19,580 (135)	
	Injection Speed	in/s (mm/s)	9.45 (240)			6.30 (160)				6.30 (160)		
	Injection Rate	in <sup>3</sup> /s (cm <sup>3</sup> /s)	18.4 (302)	24.3 (399)	29.9 (490)	16.2 (266)	21.5 (353)	25.8 (423)	25.8 (423)	33.4 (547)	39.7 (651)	
	Plasticizing Rate (GP-PS)	oz/s (kg/h)	1.27 (130)	1.80 (184)	2.27 (232)	1.13 (115)	1.60 (163)	1.93 (197)	1.93 (197)	2.76 (282)	3.29 (336)	
	Screw Speed	rpm (min <sup>-1</sup> )	400			250				250		
High Speed (Option)	Injection Pressure (Max.)	psi (Mpa)	36,260 (250)	27,410 (189)	22,340 (154)	33,940 (234)	25,670 (177)	21,320 (147)	33,210 (229)	25,670 (177)	21,610 (149)	
	Holding Pressure (Max.)	psi (Mpa)	32,920 (227)	24,950 (172)	20,310 (140)	30,890 (213)	23,350 (161)	19,430 (134)	30,170 (208)	23,350 (161)	19,580 (135)	
	Injection Speed	in/s (mm/s)	12.99 (330)			11.81 (300)				10.63 (270)		
	Injection Rate	in <sup>3</sup> /s (cm <sup>3</sup> /s)	25.3 (415)	33.4 (548)	41.1 (674)	30.5 (499)	40.4 (662)	48.4 (793)	43.5 (713)	56.4 (924)	67.1 (1099)	
	Plasticizing Rate (GP-PS)	oz/s (kg/h)	1.27 (130)	1.80 (184)	2.27 (232)	1.58 (161)	2.23 (228)	2.69 (275)	1.93 (197)	2.76 (282)	3.29 (336)	
Screw Speed	rpm (min <sup>-1</sup> )	400			350				250			
Nozzle Touch Force		U.S.ton (kN)	4.4 (39.3) Center Nozzle Touch									
Nozzle Stroke from Platen		in (mm)	1.97 (50)									
Type of Nozzle			Open Nozzle (Tip Type)									
Barrel Temperature Control			Barrel4, Nozzle1			Barrel5, Nozzle1						
Heater Wattage		kW	12.0			12.4				18.7		
Mechanism			Double Toggle									
Clamping Force		U.S.ton (kN)	242.8 (2160)									
Daylight Opening (Max.)		in (mm)	48.43 (1230)									
Opening Stroke (Max.)		in (mm)	21.65 (550)									
Mold Height		in (mm)	9.055~26.772 (230~680)									
Distance Between Tie-bars (H×V)		in (mm)	25.59×23.23 (650×590)									
Platen Size (H×V)		in (mm)	36.61×34.25 (930×870)									
Locating Ring Diameter		in (mm)	4.0 (101.6)									
Ejector Point			13 Points									
Ejector Force		U.S.ton (kN)	4.97 (44.2)									
Ejector Stroke		in (mm)	5.906 (150)									
General	Machine Weight	U.S.ton (t)	11.57 (10.5)			12.24 (11.1)				12.79 (11.6)		
	Machine Dimensions (L×W×H)	ft (m)	21.42×5.64×6.56 (6.53×1.72×2.00)			21.42×5.64×6.66 (6.53×1.72×2.03)				23.04×5.63×6.77 (7.02×1.72×2.06)		

- Remarks:
- Maximum injection pressure and maximum holding pressure may be restricted due to molding condition.
  - The theoretical injection capacity is (cross sectional area of barrel) × (stroke of screw).
  - The injection capacity is applicable for GP-PS and variable according to the grade of resin, molding conditions and mold.
  - The plasticizing rate is applicable for GP-PS.
  - PC, HPVC, other engineering plastic, etc., low temperature setting and high speed molding may require a high torque depending on the grade or molding conditions. Please contact us if you plan.
- Note:
- Due to continual improvements, specifications are subject to change without notice.
  - Actual figures of the specification will vary depending on final machine configuration. Please contact us if you require more specific data.
  - Performance specifications are based on theoretical data.
  - High speed injection is optional.
  - 1MPa=10.2 kgf/cm<sup>2</sup>, 1kN=0.102t

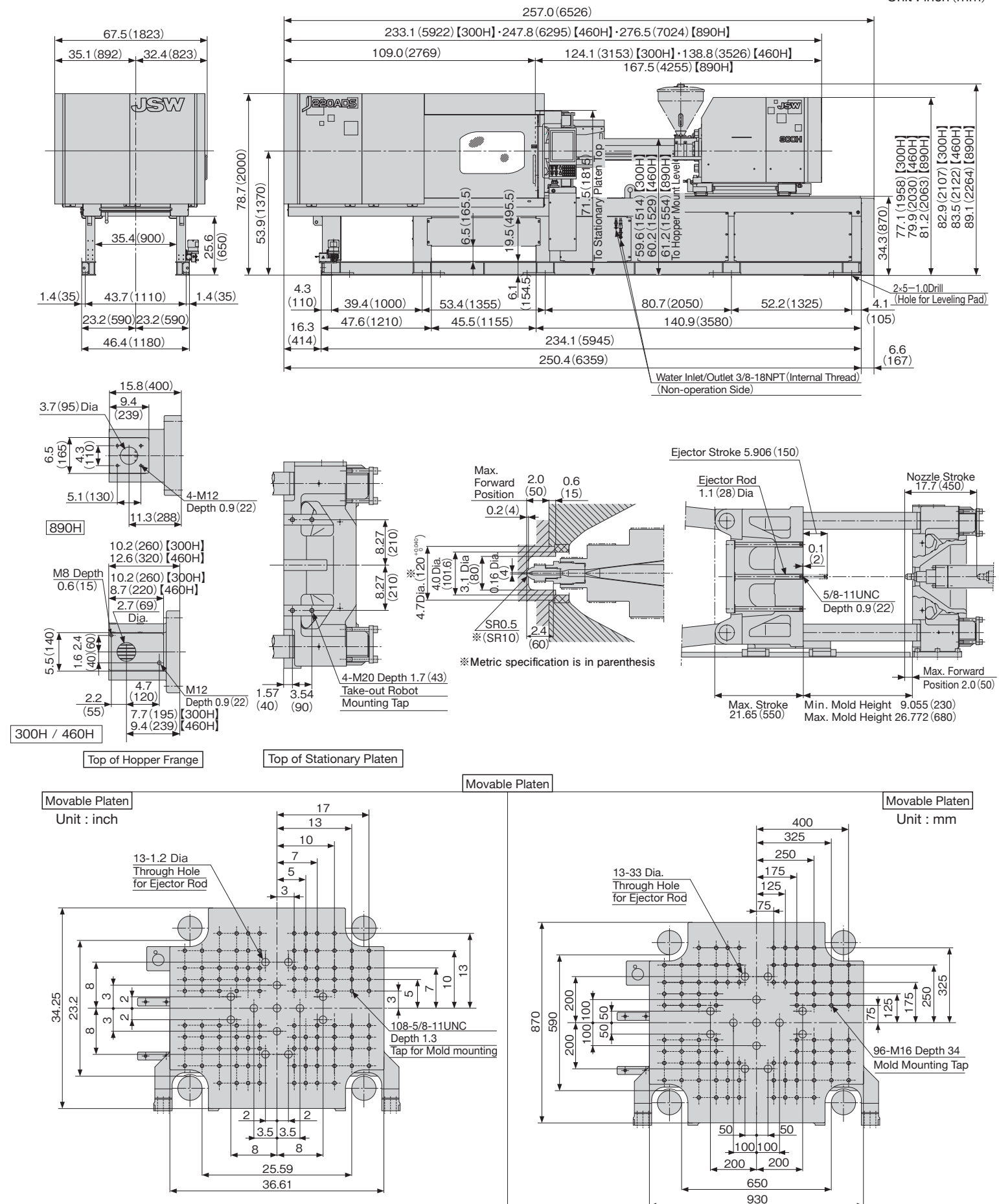

Performance Table

Equipment Dimensions and Mold Related Dimensions

Unit : inch (mm)

Unit	Item	Model	J280ADS						
			460H			890H			
Injection Unit	Screw Diameter	in (mm)	1.81 (46)	2.09 (53)	2.28 (58)	2.28 (58)	2.60 (66)	2.83 (72)	
	Screw Stroke	in (mm)	8.268 (210)			10.236 (260)			
	Theoretical Injection Capacity	in <sup>3</sup> (cm <sup>3</sup> )	21.30 (349)	28.26 (463)	33.87 (555)	41.93 (687)	54.31 (890)	64.63 (1059)	
	Injection Capacity (GP-PS)	oz (g)	11.2 (318)	14.9 (421)	17.8 (505)	22.0 (625)	28.6 (810)	34.0 (965)	
	Standard	Injection Pressure (Max.)	psi (Mpa)	33940 (234)	25670 (177)	21320 (147)	33210 (229)	25670 (177)	21610 (149)
		Holding Pressure (Max.)	psi (Mpa)	30890 (213)	23350 (161)	19430 (134)	30170 (208)	23350 (161)	19580 (135)
	Injection Unit	Injection Speed	in/s (mm/s)	6.30 (160)			6.30 (160)		
		Injection Rate	in <sup>3</sup> /s (cm <sup>3</sup> /s)	16.2 (266)	21.5 (353)	25.8 (423)	25.8 (423)	33.4 (547)	39.7 (651)
		Plasticizing Rate (GP-PS)	oz/s (kg/h)	1.13 (115)	1.60 (163)	1.93 (197)	1.93 (197)	2.76 (282)	3.29 (336)
	High Speed (Option)	Screw Speed	rpm (min <sup>-1</sup> )	250			250		
Injection Pressure (Max.)		psi (Mpa)	33940 (234)	25670 (177)	21320 (147)	33210 (229)	25670 (177)	21610 (149)	
High Speed (Option)	Holding Pressure (Max.)	psi (Mpa)	30890 (213)	23350 (161)	19430 (134)	30170 (208)	23350 (161)	19580 (135)	
	Injection Speed	in/s (mm/s)	11.81 (300)			10.63 (270)			
High Speed (Option)	Injection Rate	in <sup>3</sup> /s (cm <sup>3</sup> /s)	30.5 (499)	40.4 (662)	48.4 (793)	43.5 (713)	56.4 (924)	67.1 (1099)	
	Plasticizing Rate (GP-PS)	oz/s (kg/h)	1.58 (161)	2.23 (228)	2.69 (275)	1.93 (197)	2.76 (282)	3.29 (336)	
High Speed (Option)	Screw Speed	rpm (min <sup>-1</sup> )	350			250			
	Nozzle Touch Force	U.S.ton (kN)	4.4 (39.3) Center Nozzle Touch						
Clamping Unit	Nozzle Stroke from Platen	in (mm)	1.97 (50)						
	Type of Nozzle		Open Nozzle (Tip Type)						
	Barrel Temperature Control		Barrel5, Nozzle1						
	Heater Wattage	kW	12.4			18.7			
	Mechanism		Double Toggle						
	Clamping Force	U.S.ton (kN)	309.1 (2750)						
	Daylight Opening (Max.)	in (mm)	51.97 (1320)						
	Opening Stroke (Max.)	in (mm)	23.62 (600)						
	Mold Height	in (mm)	9.843~28.347 (250~720)						
	Distance Between Tie-bars (H×V)	in (mm)	28.74×24.80 (730×630)						
Clamping Unit	Platen Size (H×V)	in (mm)	41.34×36.81 (1050×935)						
	Locating Ring Diameter	in (mm)	4.0 (101.6)						
	Ejector Point		13 points						
	Ejector Force	U.S.ton (kN)	6.63 (59.0)						
	Ejector Stroke	in (mm)	5.906 (150)						
General	Machine Weight	U.S.ton (t)	13.67 (12.4)			14.33 (13.0)			
	Machine Dimensions (L×W×H)ft (m)		22.15×5.91×6.82 (6.75×1.80×2.08)			23.88×5.91×6.92 (7.28×1.80×2.11)			

Remarks:  
 1. Maximum injection pressure and maximum holding pressure may be restricted due to molding condition.  
 2. The theoretical injection capacity is (cross sectional area of barrel) × (stroke of screw).  
 3. The injection capacity is applicable for GP-PS and variable according to the grade of resin, molding conditions and mold.  
 4. The plasticizing rate is applicable for GP-PS.  
 5. PC, HPVC, other engineering plastic, etc., low temperature setting and high speed molding may require a high torque depending on the grade or molding conditions. Please contact us if you plan.

Note:  
 1. Due to continual improvements, specifications are subject to change without notice.  
 2. Actual figures of the specification will vary depending on final machine configuration. Please contact us if you require more specific data.  
 3. Performance specifications are based on theoretical data.  
 4. High speed injection is optional.  
 5. 1MPa=10.2 kgf/cm<sup>2</sup>, 1kN=0.102tf

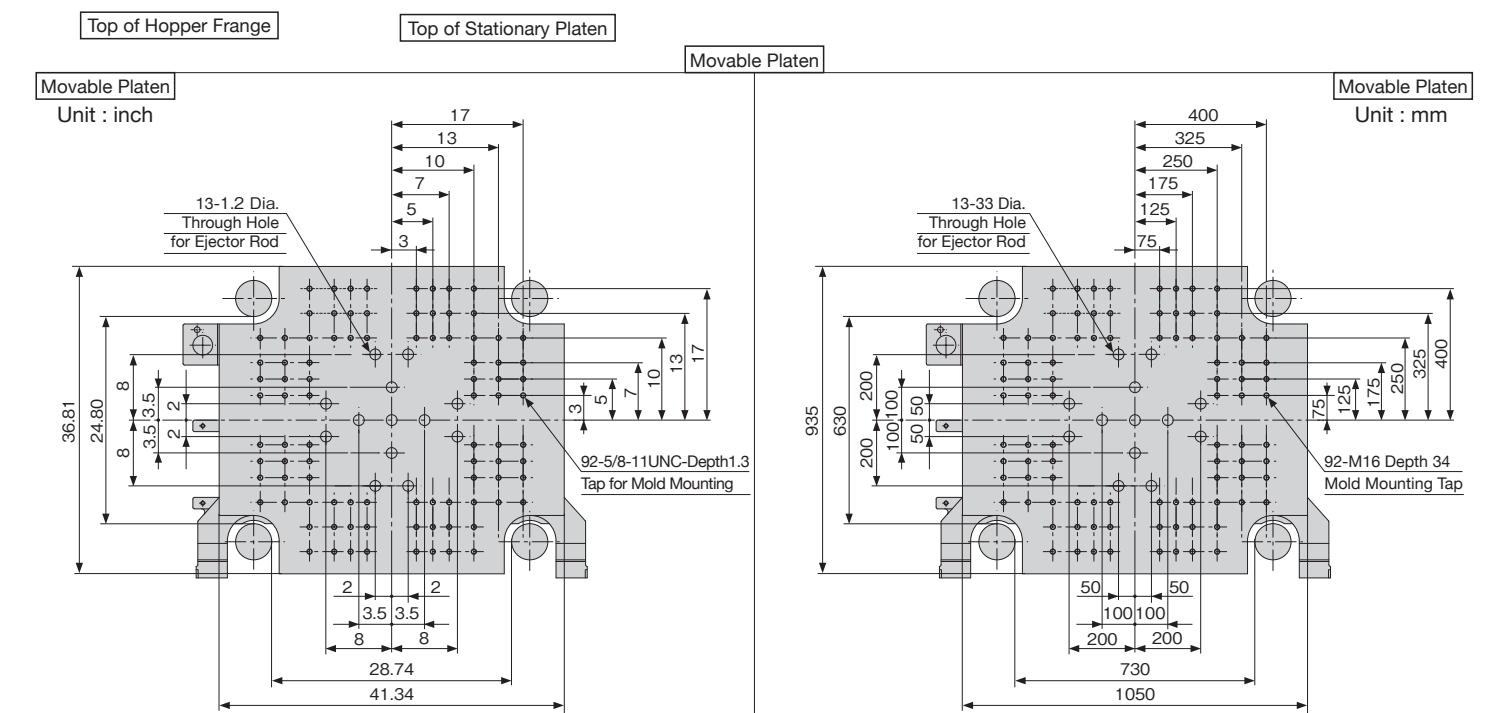
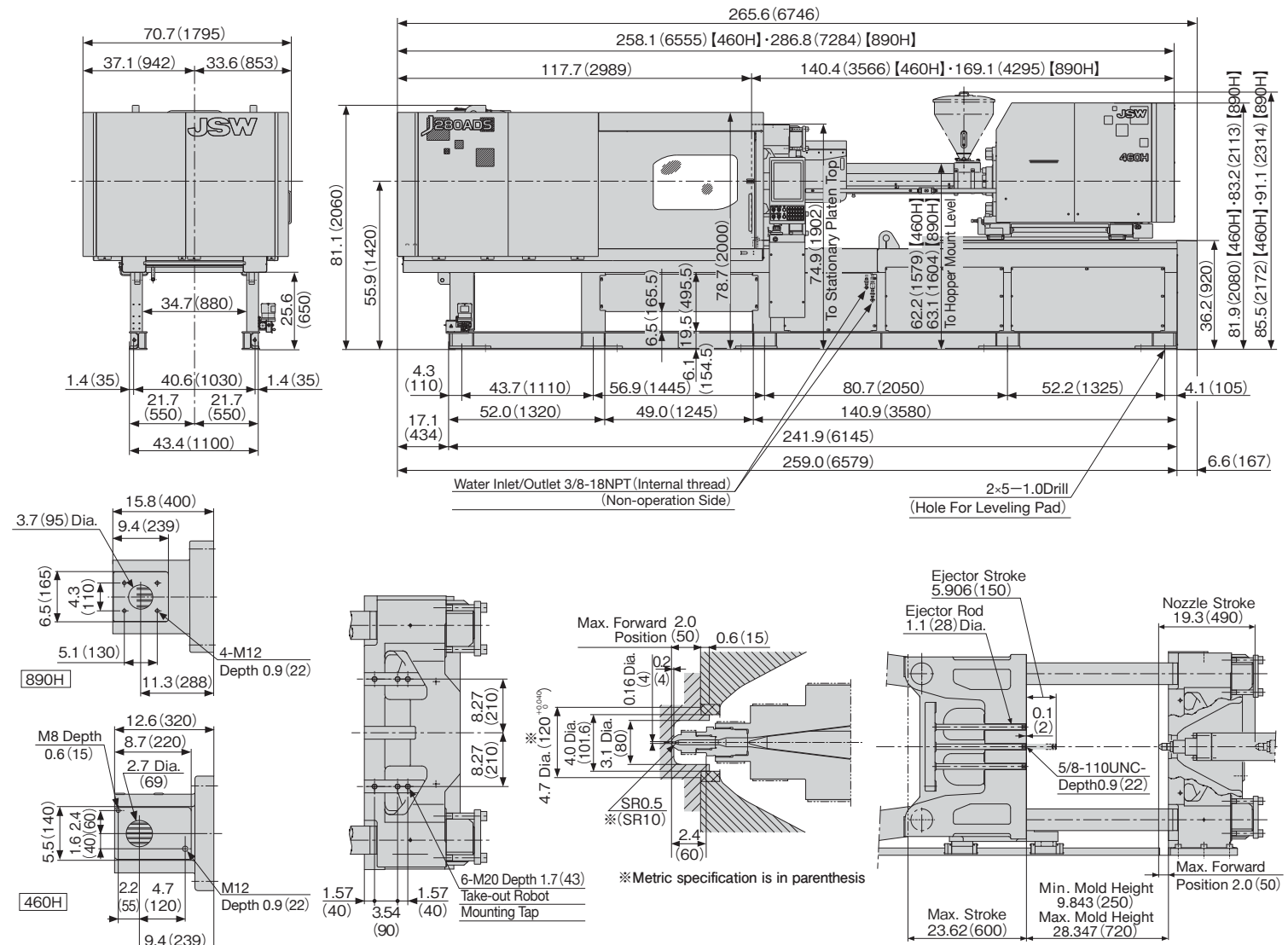

Performance Table

Equipment Dimensions and Mold Related Dimensions

Unit : inch (mm)

Unit	Item	Model	J350ADS									
			460H			890H			1400H			
Injection Unit	Screw Diameter	in (mm)	1.81 (46)	2.09 (53)	2.28 (58)	2.28 (58)	2.60 (66)	2.83 (72)	2.60 (66)	2.99 (76)	3.31 (84)	
	Screw Stroke	in (mm)	8.268 (210)			10.236 (260)			11.811 (300)			
	Theoretical Injection Capacity	in <sup>3</sup> (cm <sup>3</sup> )	21.30 (349)	28.26 (463)	33.87 (555)	41.93 (687)	54.31 (890)	64.63 (1059)	62.61 (1026)	83.06 (1361)	101.49 (1663)	
	Injection Capacity (GP-PS)	oz (g)	11.2 (318)	14.9 (421)	17.8 (505)	22.0 (625)	28.6 (810)	34.0 (965)	32.9 (934)	43.7 (1238)	53.4 (1513)	
	Standard	Injection Pressure (Max.)	psi (Mpa)	33940 (234)	25670 (177)	21320 (147)	33210 (229)	25670 (177)	21610 (149)	34950 (241)	26400 (182)	21610 (149)
		Holding Pressure (Max.)	psi (Mpa)	30890 (213)	23350 (161)	19430 (134)	30170 (208)	23350 (161)	19580 (135)	31330 (216)	23640 (163)	19430 (134)
		Injection Speed	in/s (mm/s)	6.30 (160)			6.30 (160)			6.30 (160)		
		Injection Rate	in <sup>3</sup> /s (cm <sup>3</sup> /s)	16.2 (266)	21.5 (353)	25.8 (423)	25.8 (423)	33.4 (547)	39.7 (651)	33.4 (547)	44.3 (726)	54.1 (887)
		Plasticizing Rate (GP-PS)	oz/s (kg/h)	1.13 (115)	1.60 (163)	1.93 (197)	1.93 (197)	2.76 (282)	3.29 (336)	2.32 (237)	3.31 (338)	4.10 (418)
		Screw Speed	rpm (min <sup>-1</sup> )	250			250			210		
High Speed (Option)	Injection Pressure (Max.)	psi (Mpa)	33940 (234)	25670 (177)	21320 (147)	33210 (229)	25670 (177)	21610 (149)	34950 (241)	26400 (182)	21610 (149)	
	Holding Pressure (Max.)	psi (Mpa)	30890 (213)	23350 (161)	19430 (134)	30170 (208)	23350 (161)	19580 (135)	31330 (216)	23640 (163)	19430 (134)	
	Injection Speed	in/s (mm/s)	11.81 (300)			10.63 (270)			11.81 (300)			
	Injection Rate	in <sup>3</sup> /s (cm <sup>3</sup> /s)	30.5 (499)	40.4 (662)	48.4 (793)	43.5 (713)	56.4 (924)	67.1 (1099)	62.6 (1026)	83.1 (1361)	101.5 (1663)	
	Plasticizing Rate (GP-PS)	oz/s (kg/h)	1.58 (161)	2.23 (228)	2.69 (275)	1.93 (197)	2.76 (282)	3.29 (336)	2.32 (237)	3.31 (338)	4.10 (418)	
	Screw Speed	rpm (min <sup>-1</sup> )	350			250			210			
Clamping Unit	Nozzle Touch Force	U.S.ton (kN)	4.4 (39.3) Center Nozzle Touch									
	Nozzle Stroke from Platen	in (mm)	1.97 (50)									
	Type of Nozzle		Open Nozzle (Tip Type)									
	Barrel Temperature Control		Barrel5, Nozzle1									
	Heater Wattage	kW	12.4			18.7			26.8			
	Mechanism		Double Toggle									
	Clamping Force	U.S.ton (kN)	386.7 (3440)									
	Daylight Opening (Max.)	in (mm)	57.88 (1470)									
	Opening Stroke (Max.)	in (mm)	27.56 (700)									
	Mold Height	in (mm)	11.811~30.316 (300~770)									
General	Distance Between Tie-bars (H×V)	in (mm)	31.89×28.74 (810×730)									
	Platen Size (H×V)	in (mm)	45.87×42.72 (1165×1085)									
	Locating Ring Diameter	in (mm)	4.0 (101.6)									
	Ejector Point		17 points									
	Ejector Force	U.S.ton (kN)	6.63 (59.0)									
	Ejector Stroke	in (mm)	5.906 (150)									
	Machine Weight	U.S.ton (t)	17.75 (16.1)			18.74 (17.0)			20.39 (18.5)			
Machine Dimensions (L×W×H)	ft (m)	23.49×6.53×6.86 (7.16×1.99×2.09)			24.97×6.53×6.86 (7.61×1.99×2.09)			25.59×6.53×7.05 (7.80×1.99×2.15)				

Remarks:  
 1. Maximum injection pressure and maximum holding pressure may be restricted due to molding condition.  
 2. The theoretical injection capacity is (cross sectional area of barrel) × (stroke of screw).  
 3. The injection capacity is applicable for GP-PS and variable according to the grade of resin, molding conditions and mold.  
 4. The plasticizing rate is applicable for GP-PS.  
 5. PC, HPVC, other engineering plastic, etc., low temperature setting and high speed molding may require a high torque depending on the grade or molding conditions.  
 Please contact us if you plan.

Note:  
 1. Due to continual improvements, specifications are subject to change without notice.  
 2. Actual figures of the specification will vary depending on final machine configuration. Please contact us if you require more specific data.  
 3. Performance specifications are based on theoretical data.  
 4. High speed injection is optional.  
 5. 1MPa=10.2 kgf/cm<sup>2</sup>, 1kN=0.102tf

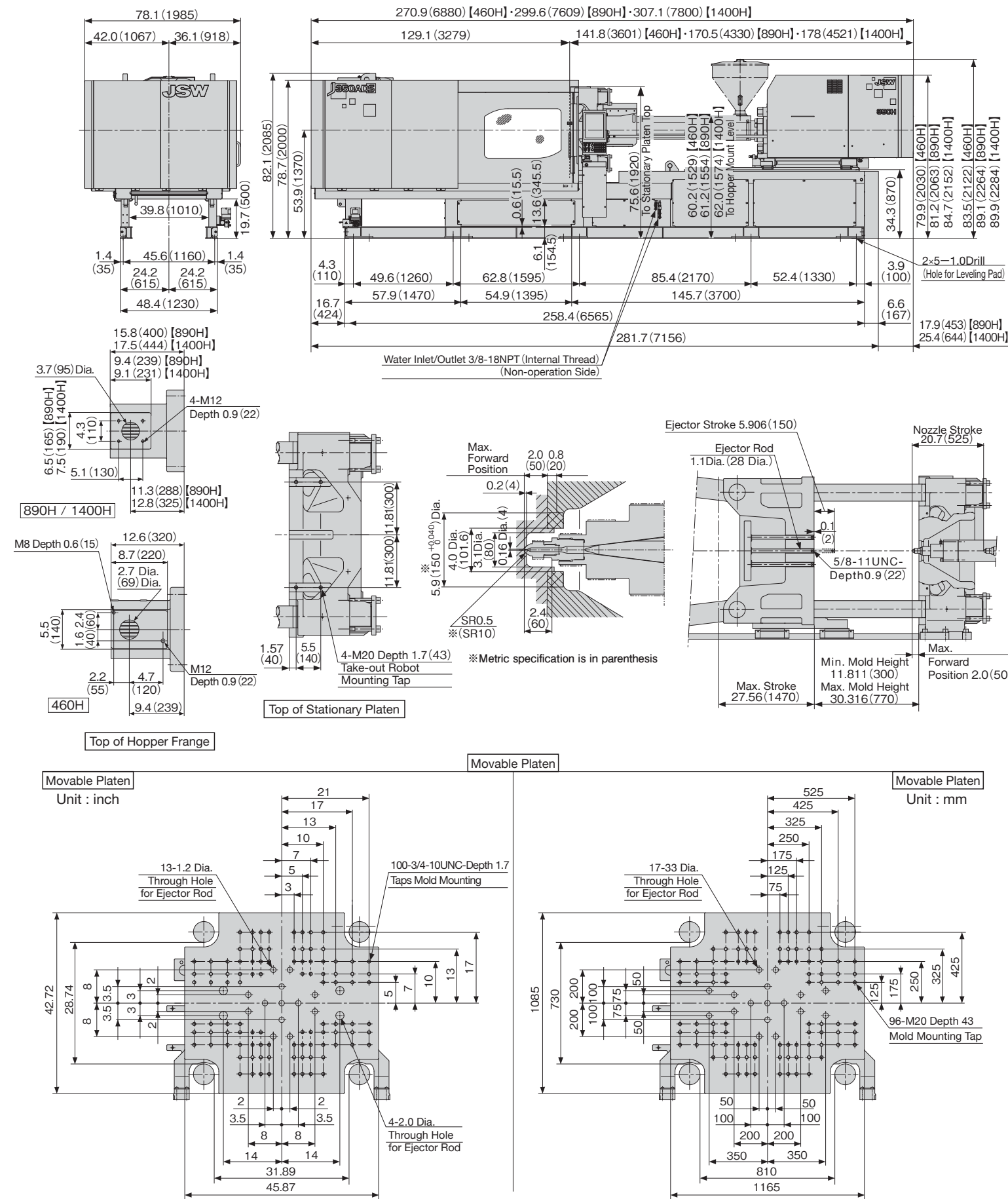

## Performance Table

Unit	Item	Model	J450ADS								
			890H			1400H		2300H			
Injection Unit	Screw Diameter	in (mm)	2.28 (58)	2.60 (66)	2.83 (72)	2.60 (66)	2.99 (76)	3.31 (84)	3.31 (84)	3.62 (92)	
	Screw Stroke	in (mm)	10.236 (260)			11.811 (300)		16.536 (420)			
	Theoretical Injection Capacity	in <sup>3</sup> (cm <sup>3</sup> )	41.93 (687)	54.31 (890)	64.63 (1059)	62.61 (1026)	83.06 (1361)	101.49 (1663)	142.07 (2328)	170.39 (2792)	
	Injection Capacity (GP-PS)	oz (g)	22.0 (625)	28.6 (810)	34.0 (965)	32.9 (934)	43.7 (1238)	53.4 (1513)	74.7 (2118)	89.6 (2541)	
	Standard	Injection Pressure (Max.)	psi (Mpa)	33210 (229)	25670 (177)	21610 (149)	34950 (241)	26400 (182)	21610 (149)	27560 (190)	22920 (158)
		Holding Pressure (Max.)	psi (Mpa)	30170 (208)	23350 (161)	19580 (135)	31330 (216)	23640 (163)	19430 (134)	24800 (171)	20600 (142)
	Standard	Injection Speed	in/s (mm/s)	6.30 (160)			6.30 (160)		6.30 (160)		
		Injection Rate	in <sup>3</sup> /s (cm <sup>3</sup> /s)	25.8 (423)	33.4 (547)	39.7 (651)	33.4 (547)	44.3 (726)	54.1 (887)	54.1 (887)	64.9 (1064)
	Standard	Plasticizing Rate (GP-PS)	oz/s (kg/h)	1.93 (197)	2.76 (282)	3.29 (336)	2.32 (237)	3.31 (338)	4.10 (418)	4.12 (420)	4.61 (470)
		Screw Speed	rpm (min <sup>-1</sup> )	250			210		200		180
High Speed (Option)	Injection Pressure (Max.)	psi (Mpa)	33210 (229)	25670 (177)	21610 (149)	34950 (241)	26400 (182)	21610 (149)	Not Applicable		
	Holding Pressure (Max.)	psi (Mpa)	30170 (208)	23350 (161)	19580 (135)	31330 (216)	23640 (163)	19430 (134)			
High Speed (Option)	Injection Speed	in/s (mm/s)	10.63 (270)			11.81 (300)					
	Injection Rate	in <sup>3</sup> /s (cm <sup>3</sup> /s)	43.5 (713)	56.4 (924)	67.1 (1099)	62.6 (1026)	83.1 (1361)	101.5 (1663)			
High Speed (Option)	Plasticizing Rate (GP-PS)	oz/s (kg/h)	1.93 (197)	2.76 (282)	3.29 (336)	2.32 (237)	3.31 (338)	4.10 (418)			
	Screw Speed	rpm (min <sup>-1</sup> )	250			210					
Clamping Unit	Nozzle Touch Force	U.S.ton (kN)	4.4 (39.3) Center Nozzle Touch						6.6 (59.0)		
	Nozzle Stroke from Platen	in (mm)	1.97 (50)								
	Type of Nozzle		Open Nozzle (Tip type)						Open Nozzle		
	Barrel Temperature Control		Barrel 5, Nozzle 1								
	Heater Wattage	kW	18.7			26.8		39.8			
	Mechanism		Double Toggle								
	Clamping Force	U.S.ton (kN)	496.8 (4420)								
	Daylight Opening (Max.)	in (mm)	66.93 (1700)								
	Opening Stroke (Max.)	in (mm)	31.50 (800)								
	Mold Height	in (mm)	13.780~35.434 (350~900)								
General	Distance Between Tie-bars (H×V)	in (mm)	35.43×31.89 (900×810)								
	Platen Size (H×V)	in (mm)	51.18×47.64 (1300×1210)								
	Locating Ring Diameter	in (mm)	4.0 (101.6)								
	Ejector Point		17 points								
	Ejector Force	U.S.ton (kN)	11.13 (99.0)								
	Ejector Stroke	in (mm)	7.078 (180)								
	Machine Weight	U.S.ton (t)	23.15 (21.0)			24.58 (22.3)		28.88 (26.2)			
Machine Dimensions (L×W×H)	ft (m)	26.61×7.02×6.96 (8.11×2.14×2.12)			27.07×7.02×7.25 (8.25×2.14×2.21)		30.49×7.02×7.74 (9.29×2.14×2.36)				

- Remarks:
- Maximum injection pressure and maximum holding pressure may be restricted due to molding condition.
  - The theoretical injection capacity is (cross sectional area of barrel) × (stroke of screw).
  - The injection capacity is applicable for GP-PS and variable according to the grade of resin, molding conditions and mold.
  - The plasticizing rate is applicable for GP-PS.
  - PC, HPVC, other engineering plastic, etc., low temperature setting and high speed molding may require a high torque depending on the grade or molding conditions. Please contact us if you plan.

- Note:
- Due to continual improvements, specifications are subject to change without notice.
  - Actual figures of the specification will vary depending on final machine configuration. Please contact us if you require more specific data.
  - Performance specifications are based on theoretical data.
  - High speed injection is optional.
  - 1MPa=10.2 kgf/cm<sup>2</sup>, 1kN=0.102t

## Equipment Dimensions and Mold Related Dimensions

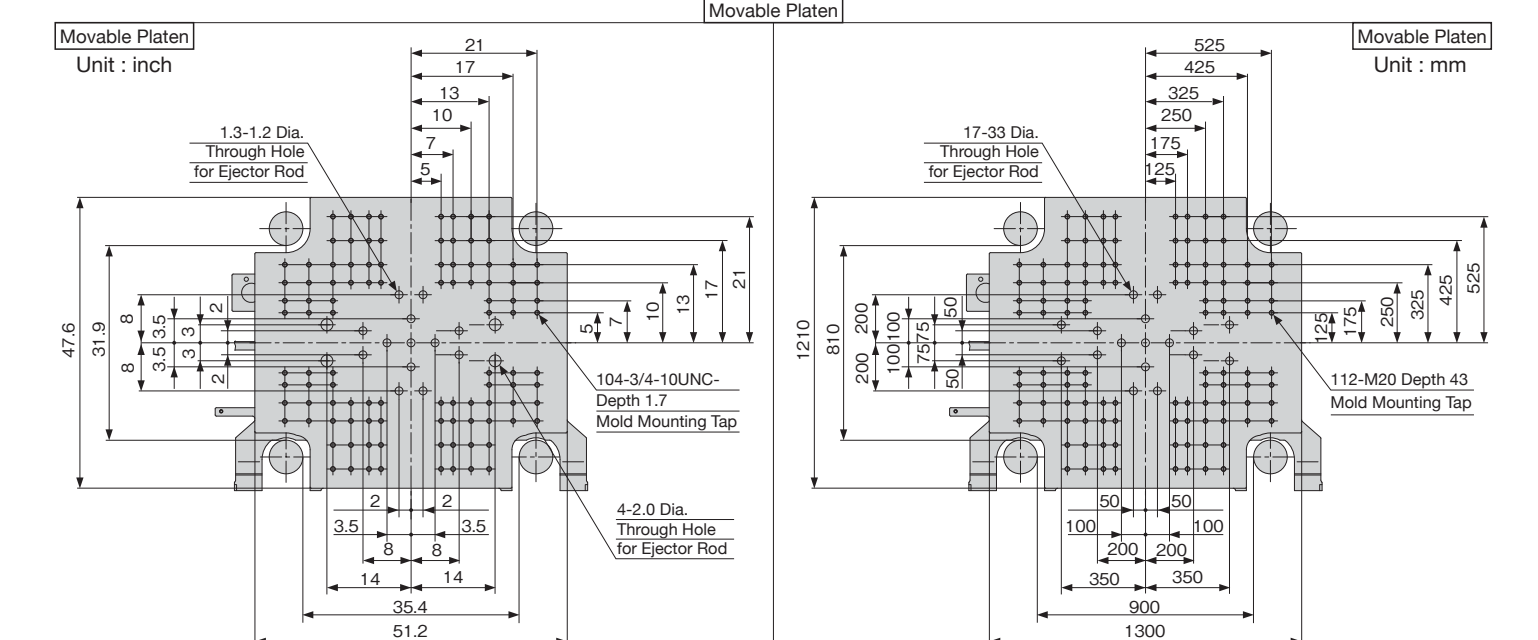
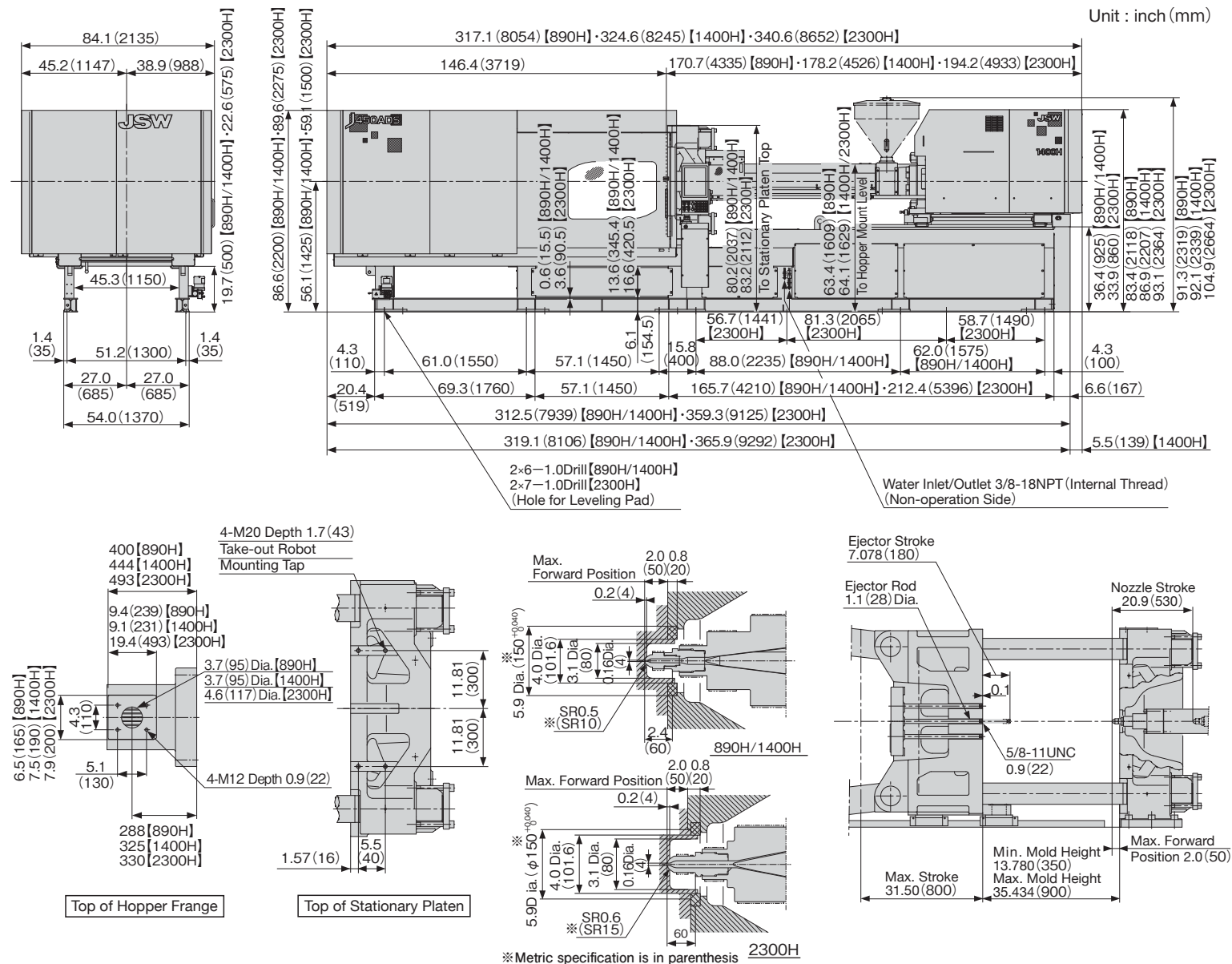

### Standard Equipment List

Item		
Injection unit	Open Nozzle(Tip type)/(Injection Units up to 1400H) (Note 1)	
	N2000F Barrel	
	Chrome-plated Screw (Note 2)	
	Screw Pull-back	
	Injection Unit Swiveling Device(with Limit Switch)	
	Screw Cold Start Prevention	
	Molding/Purging/Pause Temperature Select	
	Auto Purging Circuit	
	Nozzle Retract Select	
	Injection/Metering Programmed Control	Injection/Holding Pressure:1 to 6 Steps (Variable) Metering/Back Pressure:1 to 3 Steps (Variable)
	Holding Pressure Control Select	
	Pull-back Select	
	IVS Control (Holding Pressure Transfer by Speed Detection)	
	Barrel Temperature Control (PID)	
	Synchronous Temperature Rise Control	
	Hopper Flange Temperature Control	
	Soft Pack Servo Control	
	HAVC (High Accuracy Volume Control)	
	IWCS (Injection Weight and Cushion Stability) Control	
	Reverse seal Control	
Auto Grease Lubrication		
Clamping unit	High-performance Platen Support	
	Low Vibration Mold Open/Close	
	Wide Platen	
	Flat Press Platen Mechanism (Stationary side/Movable side)	
	Mold Open/Close and Ejection Programmed Control	Mold Open/Close : 4 Steps (Fixed) Ejection : 1 to 3 Steps (Variable)
	Mold Protection Function	
	Electric-driven Mold Thickness Adjusting Device	
	Auto Clamp Force Setting	
	Clamp Force Display	
	Clamp Force Feed Back Control	
	Ejector Plate Return Confirmation Circuit	
	Toggle Type Injection Compression Function	A-mode B-mode Compression: 1 to 6 Steps (Variable)
	Parallel Motion	Screw Rotation During Mold Open/Close Eject During Mold Open Injection During Clamp Up
	Clamping Safety Device (Mechanical/Electrical)	
	Robot Mounting Holes	
	Grease-free Toggle Bushing	
	Auto Grease Lubrication	

(Note)

- Nozzle of 2300H is one piece type nozzle.
- Screw of injection units 300H, 460H, 890H and 1400H, GP21 screw is equipped as standard.  
• Screw of injection unit 2300H, Hi-Meliter Mill screw is equipped as standard.
- USB memory device as external memory is capable of storing of molding conditions.
- Screen Capture can be saved in PNG format, and measuring data can be saved in CSV format
- The printer and the printer cables are options.
- Maximum of 16 items and alarms can be selected out of the following monitor items.  
①Cycle time ②Injection time ③Metering time ④Max Injection pressure ⑤Cushion position  
⑥Holding pressure end position ⑦Holding pressure transfer pressure ⑧Screw back pressure  
⑨Metering end position ⑩Injection start position ⑪Holding pressure transfer position  
⑫Metering torque ⑬Holding pressure transfer speed ⑭Mold close time ⑮Mold open time  
⑯Clamping force ⑰Shift stroke (HAVC) ⑱End speed (HAVC)
- Maintenance monitor based on molding condition

### Options List

Item	
Injection unit	Long Nozzle
	Shut-off Nozzles (Pneumatic Type and Hydraulic Type) (Note 1)
	KC Nozzle
	M7 Screw (High Plasticization Type)
	HP Screw (High Dispersion Type)
	LSP-2 screw (Abrasion-resistant type)
	Screws and Barrels for Optical Application
	Screws and Barrels for Super Engineered Plastics Application
	Special Screw (Note 2)
	Barrel Insulation Cover
Clamping unit	Barrel Blower Cooling Unit
	Hopper
	Hopper Slide Device (Operation Side)
	High-speed Injection
	Extended Holding Time Spec. (Note 3)
	Daylight Extension
	Mold Platen Heat Insulation Bord (5 or 10mm) (Note 4)
	Locating Rings
	Air Jet
	Core Pull Devices (Pneumatic Type and Hydraulic Type)
Valve Gate Device (Pneumatic Type and Hydraulic Type)	
Coupler joint (Hydraulic, Pneumatic)	
Hydraulic Power Pack (40L or 60L) Internal Unit	
Ejector Gate Cutting Circuit	
Unscrewing Motor Circuit	
Product Drop Detector (Photoelectric)	
Chute	
Rejecting Product Detecting Chute	
T-groove Platen	
Mold Setup Device	
Mold Clamper Device (Pneumatic Type, Hydraulic Type, Magnet Type)(Note 4)	
Mold Clamper	

Item	
Electrical instrumentation and control	Multi-language Select (1 Language Additional)
	Centralized Control System NET100
	Mold temperature display (with Mold Temperature Upper/Lower Limit Alarm)
Other	Mold Temperature Control device (with Mold Temperature Upper/Lower Limit Alarm)
	Hot Ranner Control Circuit
	Cooling Water Manifolds on Bed, Max.60C-deg.
	Cooling Water Failure Warning
	Leveling Pad for Installation
	Machine Anchoring Device
	Signal Tower (1 Color, 3 Colors)
	Export Specification (Note 5)
	Designated Color (Bed & Covers only) (Note 6)

(Note)

- Pneumatic shut-off nozzle and hydraulic shut-off nozzle can be mounted, Additional hydraulic unit is required for hydraulic type.
- Contact sales to know the application.
- The motor is prevented from being overloaded in a long holding time and high holding pressure molding condition.
- Extension nozzle is required. Ask sales to confirm the nozzle length to meet requirement.  
Note that the usable mold thickness range will change.
- Ask sales to confirm the details depending upon the final destination.
- Color sample or Muncell code is required.

### Utilities

#### ■ Total Power Capacity

Machine Model	Total Power Capacity (kVA)	
	Standard Injection	High Speed Injection
J220ADS	300H	20.0
	460H	27.0
	890H	34.0
J280ADS	460H	27.0
	890H	34.0
J350ADS	460H	27.0
	890H	35.0
	1400H	46.0
J450ADS	890H	36.0
	1400H	48.0
	2300H	56.0

- Note: 1. Total power capacity does not include external outlets.  
2. We recommend that the rated interrupting current of the main power supply breaker is more than 25 kA at AC400V/460V.

#### ■ Cooling Water Capacity for Barrel Temperature Control

Machine Model	Cooling Water Capacity for Barrel Temperature Control (ft <sup>3</sup> /h)
300H	14.12 (0.4m <sup>3</sup> /h)
460H	
890H	
1400H	21.20 (0.6m <sup>3</sup> /h)
2300H	42.38 (1.2m <sup>3</sup> /h)

Note: The above figures do not include the required quantity of water for the mold temperature controller.